

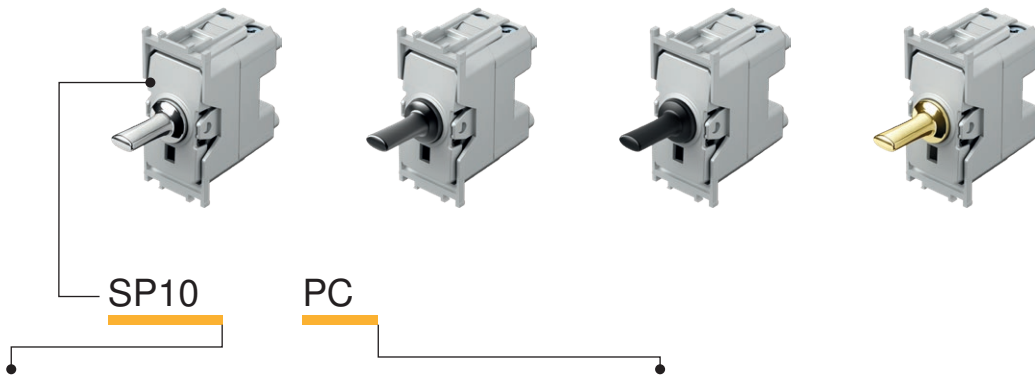

EDGE

Powered by **MODUL**

**TEM**



Тип type	Наименование description	Техническое описание technical data	Размер size	Цвет на щифтовете pin colour
SP10	ЕДНОПОЛЮСОВ КЛЮЧ SWITCH 1WAY	16AX 250V~	1M	■ PC Хром chrome
SP11	ЕДНОПОЛЮСОВ БУТОН PUSH BUTTON 1WAY	16A 250V~	1M	■ PA Антрацитен anthracite
SP12	ЕДНОПОЛЮСОВ КЛЮЧ SWITCH 1WAY	20A 250V~	1M	■ PB Черен black
·	·	·	·	■ PG Златен gold
·	·	·	·	

ЕДНОПОЛЮСОВ КЛЮЧ 16AX 250V~ 1M



- SP10PC
- SP10PA
- SP10PB
- SP10PG

- ключ
- 16AX 250V~, тип SP10
- съответства на EN 60669-1
- прикрепване на проводниците с винт 1,5-2,5 мм<sup>2</sup>

SWITCH 1WAY 16AX 250V~ 1M  
- switch  
- 16AX 250V~, type SP10  
- in accordance with EN 60669-1  
- screw contacts 1.5-2.5mm<sup>2</sup>

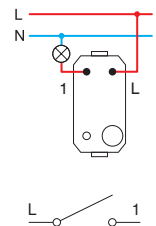

ЕДНОПОЛЮСОВ КЛЮЧ 16A 250V~ 1M



- SP11PC
- SP11PA
- SP11PB
- SP11PG

- бутон
- 16A 250V~, тип SP11
- съответства на EN 60669-1
- прикрепване на проводниците с винт 1,5-2,5 мм<sup>2</sup>

PUSH BUTTON 1WAY 16A 250V~ 1M  
- push button  
- 16A 250V~, type SP11  
- in accordance with EN 60669-1  
- screw contacts 1.5-2.5mm<sup>2</sup>

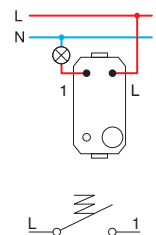

ЕДНОПОЛЮСОВ КЛЮЧ 20A 250V~ 1M



- SP12PC
- SP12PA
- SP12PB
- SP12PG

- ключ
- 20A 250V~, тип SP12
- съответства на EN 60669-1
- прикрепване на проводниците с винт 1,5-2,5 мм<sup>2</sup>

SWITCH 1WAY 20A 250V~ 1M  
- switch  
- 20A 250V~, type SP12  
- in accordance with EN 60669-1  
- screw contacts 1.5-2.5mm<sup>2</sup>

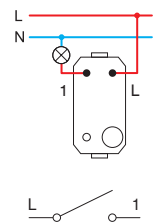

ДВУПОЛЮСЕН КЛЮЧ 16AX 250V~ 1M



- SP20PC
- SP20PA
- SP20PB
- SP20PG

- ключ
- 16AX 250V~, тип SP20
- съответства на EN 60669-1
- прикрепване на проводниците с винт 1,5-2,5 мм<sup>2</sup>
- само в комбинация с бутон TM15

SWITCH 2POLE 16AX 250V~ 1M  
- switch  
- 16AX 250V~, type SP20  
- in accordance with EN 60669-1  
- screw contacts 1.5-2.5mm<sup>2</sup>  
- only in combination with button TM15

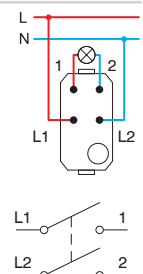



- SP40PC
- SP40PA
- SP40PB
- SP40PG

**КЛЮЧ ЗА ЩОРИ 1-0-2 16AX 250V~ 1M**

- ключ
- 16AX 250V~, тип SP40
- съответства на EN 60669-1
- прикрепване на проводниците с винт 1,5-2,5 мм<sup>2</sup>

**SWITCH SHUTTERS 1-0-2 16AX 250V~ 1M**

- switch
- 16AX 250V~, type SP40
- in accordance with EN 60669-1
- screw contacts 1.5-2.5mm<sup>2</sup>

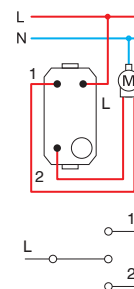

- SP41PC
- SP41PA
- SP41PB
- SP41PG

**БУТОН ЗА ЩОРИ 1-0-2 16A 250V~ 1M**

- бутон
- 16A 250V~, тип SP41
- съответства на EN 60669-1
- прикрепване на проводниците с винт 1,5-2,5 мм<sup>2</sup>

**PUSH BUTTON SHUTTERS 1-0-2 16A 250V~ 1M**

- push button
- 16A 250V~, type SP41
- in accordance with EN 60669-1
- screw contacts 1.5-2.5mm<sup>2</sup>

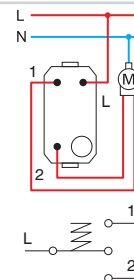

- SP60PC
- SP60PA
- SP60PB
- SP60PG

**РОТАЦИОНЕН КЛЮЧ 16AX 250V~ 1M**

- ключ
- 16AX 250V~, тип SP60
- съответства на EN 60669-1
- прикрепване на проводниците с винт 1,5-2,5 мм<sup>2</sup>

**SWITCH 2WAY 16AX 250V~ 1M**

- switch
- 16AX 250V~, type SP60
- in accordance with EN 60669-1
- screw contacts 1.5-2.5mm<sup>2</sup>

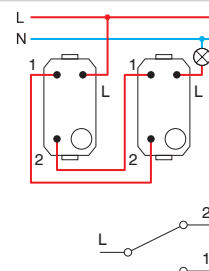

- SP61PC
- SP61PA
- SP61PB
- SP61PG

**РОТАЦИОНЕН КЛЮЧ 16A 250V~ 1M**

- бутон
- 16A 250V~, тип SP61
- съответства на EN 60669-1
- прикрепване на проводниците с винт 1,5-2,5 мм<sup>2</sup>

**PUSH BUTTON 2WAY 16A 250V~ 1M**

- push button
- 16A 250V~, type SP61
- in accordance with EN 60669-1
- screw contacts 1.5-2.5mm<sup>2</sup>

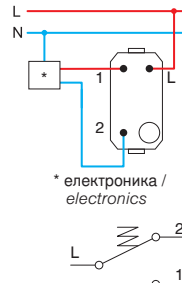

- SP70PC
- SP70PA
- SP70PB
- SP70PG

**КРЪСТАТ КЛЮЧ 16AX 250V~ 1M**

- ключ
- 16AX 250V~, тип SP70
- съответства на EN 60669-1
- прикрепване на проводниците с винт 1,5-2,5 мм<sup>2</sup>

**SWITCH INTERMEDIATE 16AX 250V~ 1M**

- switch
- 16AX 250V~, type SP70
- in accordance with EN 60669-1
- screw contacts 1.5-2.5mm<sup>2</sup>

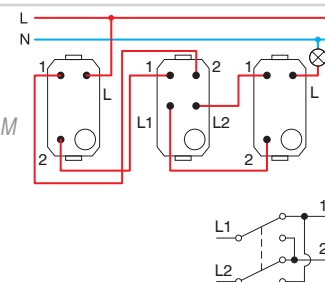

1M= 22,5 x 45

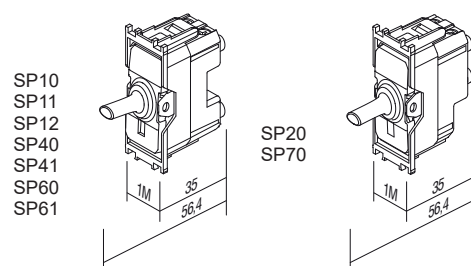

Метал  
metal

MA Сребърна  
silver



MT Антрацитна  
anthracite

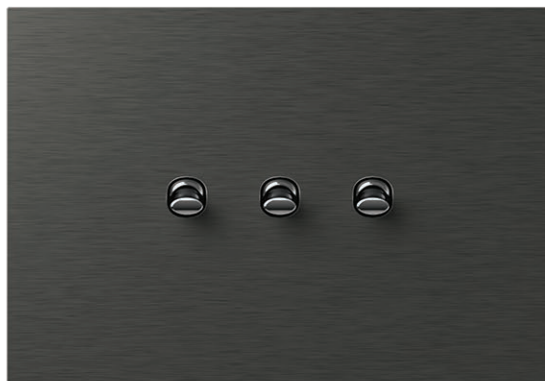

MZ Златна  
gold

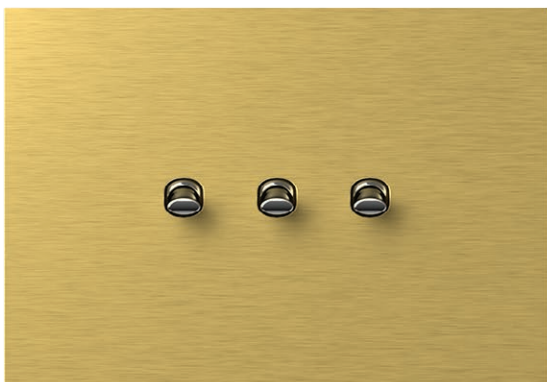

СЪКЛО  
glass

GD Черна  
glass dark



GL Бяла  
glass light

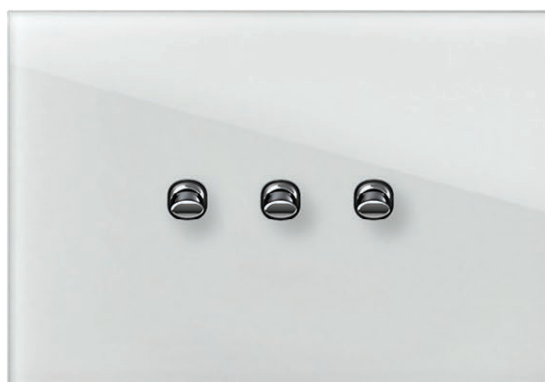

C O V E R P L A T E S E D G E O G

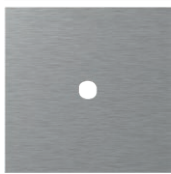
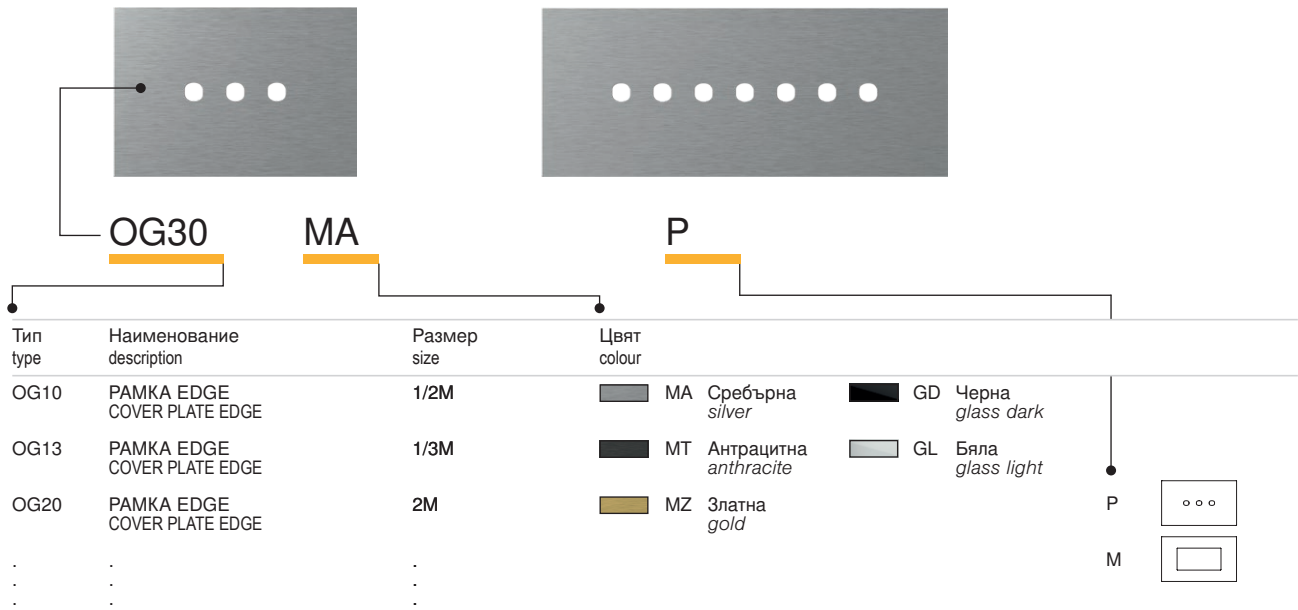

- OG10MAP
- OG10MTP
- OG10MZP
- OG10GDP
- OG10GLP

ПАМКА EDGE 1/2M

- декоративна рамка EDGE 1/2M  
- съответства на EN 60669-1  
**COVER PLATE EDGE 1/2M**  
- decorative cover plate EDGE 1/2M  
- in accordance with EN 60669-1

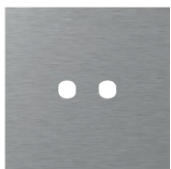

- OG20MAP
- OG20MTP
- OG20MZP
- OG20GDP
- OG20GLP

ПАМКА EDGE 2M

- декоративна рамка EDGE 2M  
- съответства на EN 60669-1  
**COVER PLATE EDGE 2M**  
- decorative cover plate EDGE 2M  
- in accordance with EN 60669-1

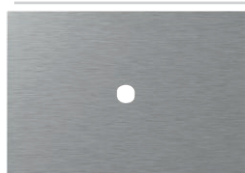

- |   |   |
|---|---|
|  OG13MAP |  OG13GDP |
|  OG13MTP |  OG13GLP |
|  OG13MZP |   |

**PAMKA EDGE 1/3M**

– декоративна рамка EDGE 1/3M  
– съответства на EN 60669-1

**COVER PLATE EDGE 1/3M**

- decorative cover plate EDGE 1/3M  
- in accordance with EN 60669-1

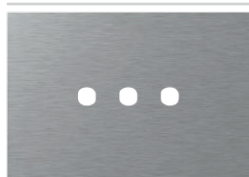

- |   |   |
|---|---|
|  OG30MAP |  OG30GDP |
|  OG30MTP |  OG30GLP |
|  OG30MZP |   |

**PAMKA EDGE 3M**

– декоративна рамка EDGE 3M  
– съответства на EN 60669-1

**COVER PLATE EDGE 3M**

- decorative cover plate EDGE 3M  
- in accordance with EN 60669-1

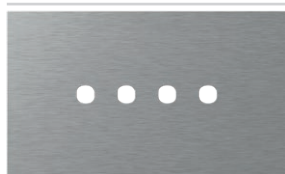

- |   |   |
|---|---|
|  OG40MAP  |  OG40GDP  |
|  OG40MTP |  OG40GLP |
|  OG40MZP |   |

**PAMKA EDGE 4M**

– декоративна рамка EDGE 4M  
– съответства на EN 60669-1

**COVER PLATE EDGE 4M**

- decorative cover plate EDGE 4M  
- in accordance with EN 60669-1

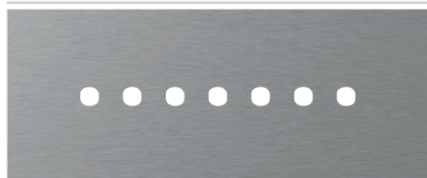

- |   |   |
|---|---|
|  OG70MAP |  OG70GDP |
|  OG70MTP |  OG70GLP |
|  OG70MZP |   |

**PAMKA EDGE 7M**

– декоративна рамка EDGE 7M  
– съответства на EN 60669-1

**COVER PLATE EDGE 7M**

- decorative cover plate EDGE 7M  
- in accordance with EN 60669-1

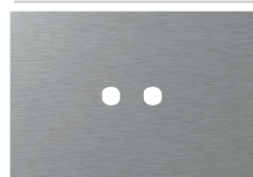

- |   |   |
|---|---|
|  OG23MAP |  OG23GDP |
|  OG23MTP |  OG23GLP |
|  OG23MZP |   |

**PAMKA EDGE 2/3M**

– декоративна рамка EDGE 2/3M  
– съответства на EN 60669-1

**COVER PLATE EDGE 2/3M**

- decorative cover plate EDGE 2/3M  
- in accordance with EN 60669-1



Метал  
metal

MA Сребърна  
silver

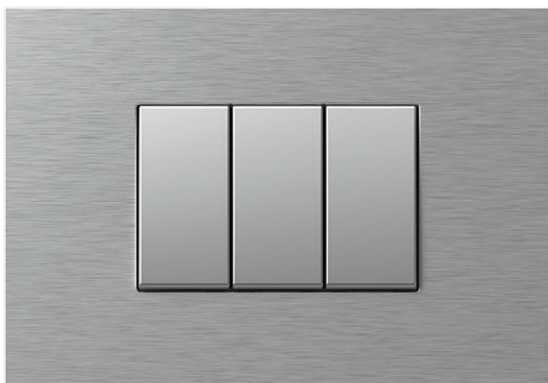

MT Антрацитна  
anthracite

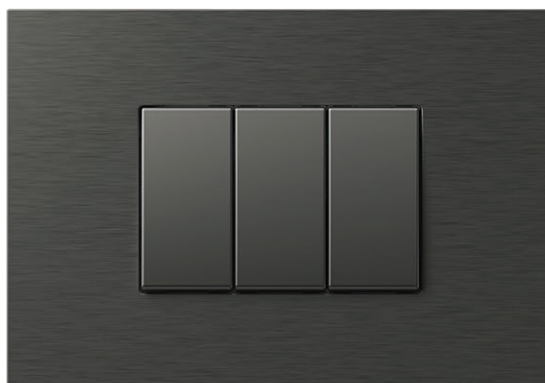

MZ Златна  
gold

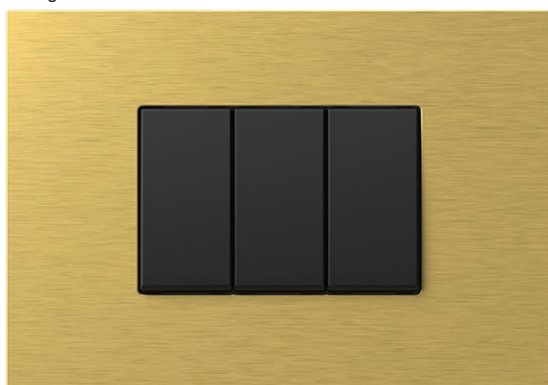

СЪКЛО  
glass

GD Черна  
glass dark

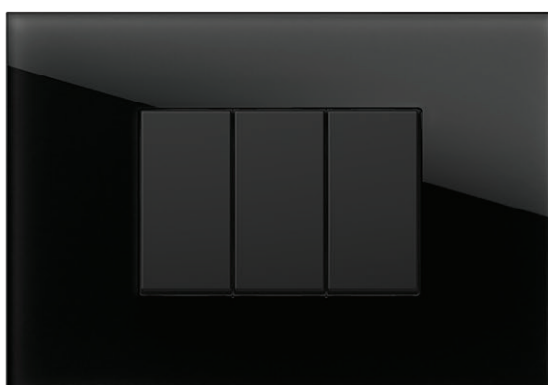

GL Бяла  
glas light

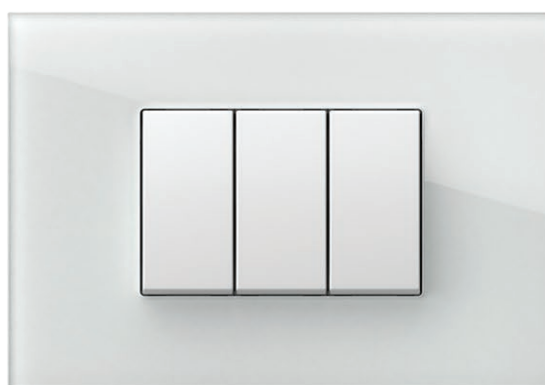



## COVER PLATES EDGE OG

Тип type	Наименование description	Размер size	Цвет colour
OG10	РАМКА EDGE COVER PLATE EDGE	1/2M	MA Сребърна silver GD Черна glass dark
OG13	РАМКА EDGE COVER PLATE EDGE	1/3M	MT Антрацитна anthracite GL Бяла glass light
OG20	РАМКА EDGE COVER PLATE EDGE	2M	MZ Златна gold
...	...	...	...

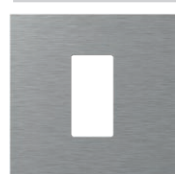

OG10MAM  
OG10MTM  
OG10MZM

OG10GDM  
OG10GLM

## РАМКА EDGE 1/2M

– декоративна рамка EDGE 1/2M  
– съответства на EN 60669-1

## COVER PLATE EDGE 1/2M

- decorative cover plate EDGE 1/2M  
- in accordance with EN 60669-1

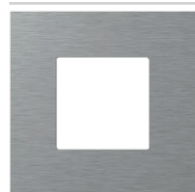

OG20MAM  
OG20MTM  
OG20MZM

OG20GDM  
OG20GLM

## РАМКА EDGE 2M

– декоративна рамка EDGE 2M  
– съответства на EN 60669-1

## COVER PLATE EDGE 2M

- decorative cover plate EDGE 2M  
- in accordance with EN 60669-1



OG24MAM  
OG24MTM  
OG24MZM

OG24GDM  
OG24GLM

## РАМКА EDGE 2x2M

– декоративна рамка EDGE 2x2M  
– хоризонтално или вертикално вграждане  
– съответства на EN 60669-1

## COVER PLATE EDGE 2x2M

- decorative cover plate EDGE 2x2M  
- horizontal or vertical mounting  
- in accordance with EN 60669-1

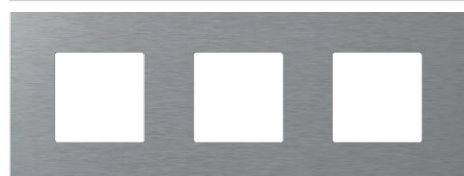

OG26MAM  
OG26MTM  
OG26MZM

OG26GDM  
OG26GLM

## РАМКА EDGE 3x2M

– декоративна рамка EDGE 3x2M  
– хоризонтално или вертикално вграждане  
– съответства на EN 60669-1

## COVER PLATE EDGE 3x2M

- decorative cover plate EDGE 3x2M  
- horizontal or vertical mounting  
- in accordance with EN 60669-1

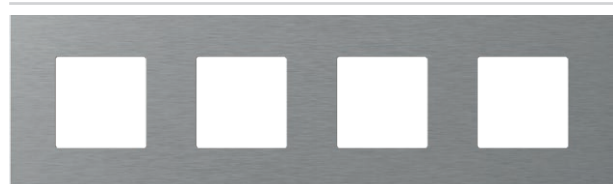

OG28MAM  
OG28MTM  
OG28MZM

OG28GDM  
OG28GLM

## РАМКА EDGE 4x2M

– декоративна рамка EDGE 4x2M  
– хоризонтално или вертикално вграждане  
– съответства на EN 60669-1

## COVER PLATE EDGE 4x2M

- decorative cover plate EDGE 4x2M  
- horizontal or vertical mounting  
- in accordance with EN 60669-1

MODUL

EDGE



 OG13MAM	 OG13GDM
 OG13MTM	 OG13GLM
 OG13MZM	

**PAMKA EDGE 1/3M**

– декоративна рамка EDGE 1/3M  
– съответства на EN 60669-1

**COVER PLATE EDGE 1/3M**

- decorative cover plate EDGE 1/3M  
- in accordance with EN 60669-1



 OG30MAM	 OG30GDM
 OG30MTM	 OG30GLM
 OG30MZM	

**PAMKA EDGE 3M**

– декоративна рамка EDGE 3M  
– съответства на EN 60669-1

**COVER PLATE EDGE 3M**

- decorative cover plate EDGE 3M  
- in accordance with EN 60669-1



 OG40MAM	 OG40GDM
 OG40MTM	 OG40GLM
 OG40MZM	

**PAMKA EDGE 4M**

– декоративна рамка EDGE 4M  
– съответства на EN 60669-1

**COVER PLATE EDGE 4M**

- decorative cover plate EDGE 4M  
- in accordance with EN 60669-1



 OG70MAM	 OG70GDM
 OG70MTM	 OG70GLM
 OG70MZM	





**PAMKA EDGE 7M**

– декоративна рамка LINE 7M  
– съответства на EN 60669-1

**COVER PLATE EDGE 7M**

- decorative cover plate EDGE 7M  
- in accordance with EN 60669-1



 OG23MAM	 OG23GDM
 OG23MTM	 OG23GLM
 OG23MZM	

**PAMKA EDGE 2/3M**

– декоративна рамка EDGE 2/3M  
– съответства на EN 60669-1

**COVER PLATE EDGE 2/3M**

- decorative cover plate EDGE 2/3M  
- in accordance with EN 60669-1

C O V E R P L A T E S E D G E O G



MODUL

EDGE

A x B



1/2M

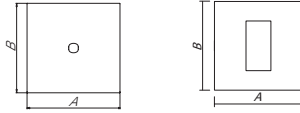

92 x 92  
mm

2M

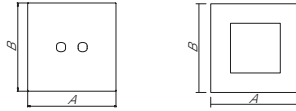

92 x 92  
mm

2x2M

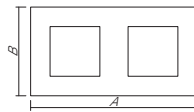

163 x 92  
mm

3x2M

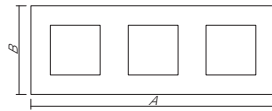

234 x 92  
mm

4x2M

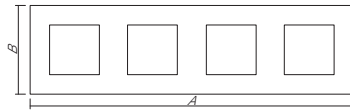

305 x 92  
mm



1/3M

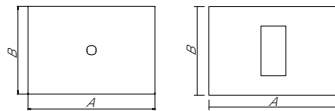

132 x 92  
mm

3M

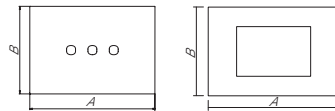

132 x 92  
mm

4M

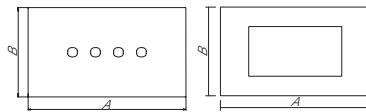

154 x 92  
mm

7M

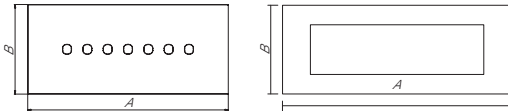

222 x 92  
mm



2/3M

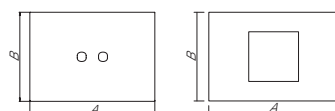

132 x 92  
mm

TECHNICAL CATALOGUE  
MODUL EDGE

2023

BG

